

SPK ELECTRONICS CO., LTD.

Engineering Specification

工程規格書

Customer	: 1167
客戶代號	
Product	: Touch Panel (Non Glare)
產品名稱	: 觸控面板(霧面)
Model	: TR4-080F-07N
型號	
Type	: Four-Wire Analog Resistive Series
類型	: 四線式類比電阻式
Version	: E/S F04-01
版次	
Date	: Apr-12-2011
日期	

Add : 10F,NO.510,SEC.5,CHUNG HSIAO E. RD, TAIPEI, TAIWAN

Tel : 02-2346-2323

Fax : 02-2346-3939

E-mail : spktw@ms34.hinet.net WEB:<http://www.spkecl.com>

SPK ELECTRONICS CO., LTD.

TABLE OF CONTENTS

目錄

	Page
	頁碼
1. FEATURES.....	4
特性說明.....	
2. DIMENSIONS & ENGINEERING DRAWING.....	4
產品尺寸和工程圖.....	
3. ENVIRONMENTAL CHARACTERISTICS.....	5
環境特性.....	
4. OPTICAL CHARACTERISTICS.....	5
光學特性.....	
5. ELECTRICAL CHARACTERISTICS.....	5
電氣特性.....	
6. MECHANICAL CHARACTERISTICS.....	6
機械特性.....	
7. RELIABILITY.....	6
信賴性特性.....	
8. DURABILITY.....	7
耐久性特性.....	
9. LINEARITY INSPECTION METHOD.....	7
線性測試方式.....	
10. APPEARANCE INSPECTIONS.....	8
外觀檢驗說明.....	
11. INSTALLATION GUIDE.....	9
組裝注意事項.....	
12. WARRANTY.....	10
產品保固.....	
13. CAUTIONS.....	11
注意事項.....	
14. APPEARANCE SPECIFICATIONS.....	12
外觀檢驗規範.....	
15. DURABILITY TEST METHOD.....	13
耐久測試方式.....	
16. CAUTIONS FOR PRODUCT HANDLING.....	14
拿取注意事項.....	
17. PACKING METHOD.....	15
包裝方式.....	

SPK ELECTRONICS CO., LTD.

1. FEATURES

特性

Type 類型	Four-Wire Analog Resistive Touch Panel 四線式類比電阻式 (RoHS)		
Structure 構造	Material 材質	Thickness 厚度	Type 類型
	ITO/PET	188um	Non-Glare 霧面
	ITO/GLASS	1.1mm	Chemical strengthened 化強
Input Mode 輸入方式	Stylus or Finger 觸控筆或手指		
Connector 連接	FPC 軟排線		

2. DIMENSIONS

Item 項目

產品尺寸

Specification (unit: mm)單位:mm	
(1)	Frame Size 外尺寸 183.00±0.30 x 141.00±0.30
(2)	View Area 可視區 169.00±0.20 x 127.50±0.20
(3)	Active Area 動作區 162.60±0.20 x 122.10±0.20
(4)	Total Thickness 總厚度 1.90±0.30
(5)	Tail Length 排線長度 80.00±1.00

[Engineering Drawing] 工程圖

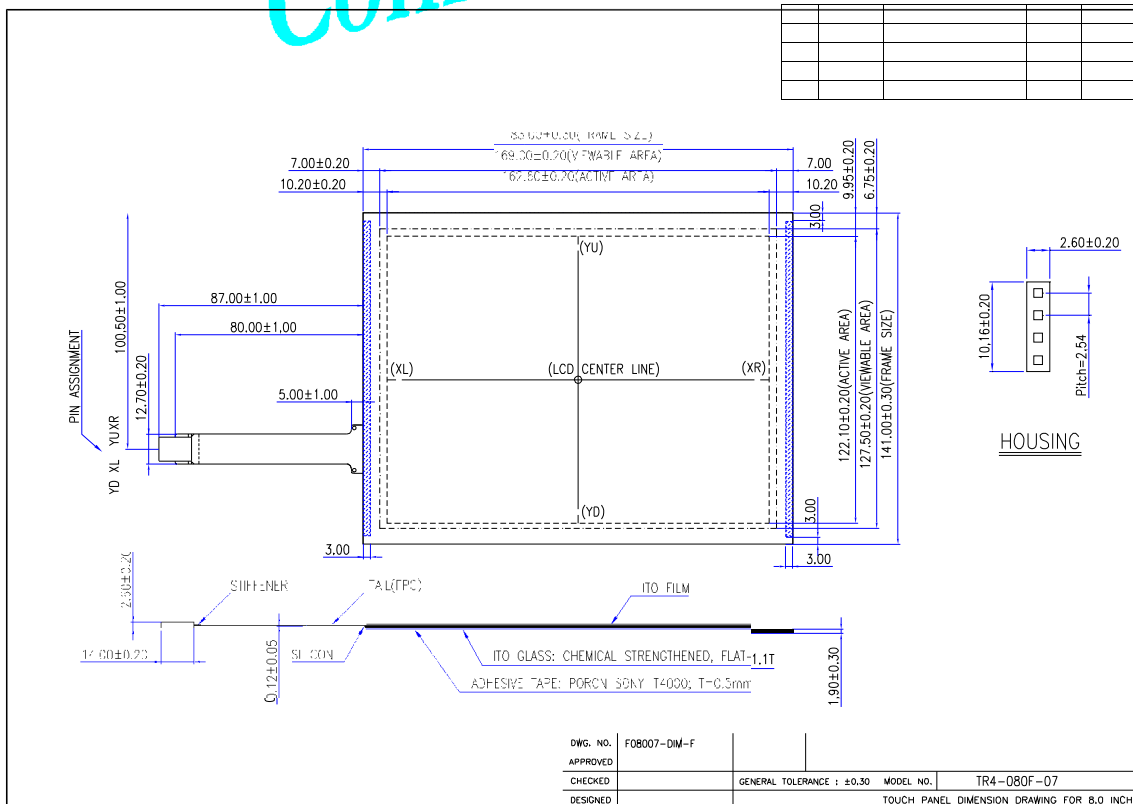

SPK ELECTRONICS CO., LTD.

3. ENVIRONMENTAL CHARACTERISTICS

Status 狀態	Temperature 溫度
(1) Operation 操作溫度	0~50°C
(2) Storage 儲存溫度	-20~70°C

Note: The environment is of normal atmosphere pressure.

註:在正常氣壓的環境

4. OPTICAL CHARACTERISTICS

光學特性

Item 項目	Specification 規格
(1) Transparency 透光度	80±2%

Note1: Transparency is measured by using BYK-Gardner instrument.

Note2: Test method-satisfy (2) of item 10 on Page 8.

註:透光度用BYK-Gardner 儀器量測。附合第8 頁,10-2 規範。

5. ELECTRICAL CHARACTERISTICS

電氣特性

Item 項目	Specification 規格
(1) Terminal Resistance 端點阻抗	XL-XR: 400~1100Ω, YU-YD: 200~700Ω ≤2.0%
(2) Linearity Tolerance 線性誤差	(Test method reference item 9 on Page 7) (測試方式參看第 7 頁第 9 項)
(3) Operation Voltage 操作電壓	5VDC
(4) Chattering 反應時間	≤30ms
(5) Insulation 絕緣阻抗	≥20MΩ, 25VDC
(6) Endurance 耐壓測試	No arcing damage at 25VDC, 60sec.
(7) Operative Resistance 操作阻抗	≤2KΩ

SPK ELECTRONICS CO., LTD.

6. MECHANICAL 機械特性 CHARACTERISTICS

Item 項目	Condition 條件	Specification 規格
(1) Activation Force 作動力	Stylus R0.8	Avg: 5~50g
(2) Impact 落球測試	Φ22.0mm Steel Ball,45g, Height=30cm	1 time, no damage (Impact at center area)
(3) Static Load 靜置荷重	15kg at Φ20mm area for 30sec	Satisfy (1), (2), (5) of item 5 and (1) of item 6
(4) Hardness 表面硬度	3H pencil, pressure 500g, 45 °(JIS K5400)	≥ 3H
(5) Tail Peeling 排線拉力強度	300g by 90 degree	Satisfy (1) of item 5
(6) Tail Bending 排線繞折強度	10 times by radius R:1mm left & right 135 degree	Satisfy (1) of item 5

7. RELIABILITY

信賴性特性

Item 項目	Condition 條件	Specification 規格
(1) Constant Temperature and Humidity	60°C, 90%RH, 120 hrs and normalized for 24 hrs	After the reliability test, the PET laye
(2) HeatCycle 高溫測試	溫度60°C 濕度90%, 120 小時回 常溫24 小時後測試 70°C, 120 hrs and normalized for 4 hrs	may have the condition of bubble; but the electrical characteristics still satisfy (1)of item 4; (1),(2),(5) of item 5;
(3) ColdCycle 低溫測試	溫度70°C, 120 小時回常溫4 小 時後測試 -20°C, 120 hrs and normalized for 4 hrs	經信賴性測試後,上層 薄膜可能會有不平整
(4) Thermal Cycle 冷熱循環	溫度-20°C, 120 小時回常溫4 小 時後測試 -20~70°C, 0.5hr each, 10 cycles and normalized for 4 hrs 溫度-20 到70°C, 各30 分鐘, 共10 個循環, 回常溫4 小時後 測試	情況, 但電氣功能仍符 合第4 項的(1)和第 5 項的(1)、(2)、(5)。

SPK ELECTRONICS CO., LTD.

8. DURABILITY

耐久性特性

Item 項目	Condition 條件	Specification 規格
(1) Finger Touch 打點測試	1,000,000 times, R8, Silicon Rubber (Please refer to page 13)	Satisfy(1),(2),(5) of item 5;
(2) Pen Sliding 劃線測試	100,000 times, R0.8, Stylus (Please refer to page 13)	Satisfy(1), (2), (5) of item 5;

9. LINEARITY INSPECTION

METHOD

線性測試方式

Voltage (DC 5V) is applied to X1 or Y2 and ground (0V) is applied to X2 or Y1.

Use stylus to draw straight lines (LX and LY) at 5 mm intervals within active area and detect the voltage at Y2 or X1 to Measure the voltage differences between X1 and X2 or Y1 and Y2.

電壓 5VDC 接到 X1 或 Y2, 0V 接到 X2 或 Y1。使用塑膠筆在動作區內劃間隔

5mm 的 LX 和 LY 的線條。量測 X1 和 X2 或 Y1 和 Y2 之間的電壓。

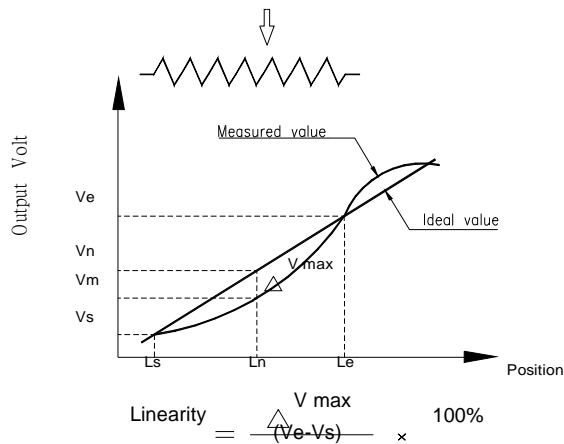
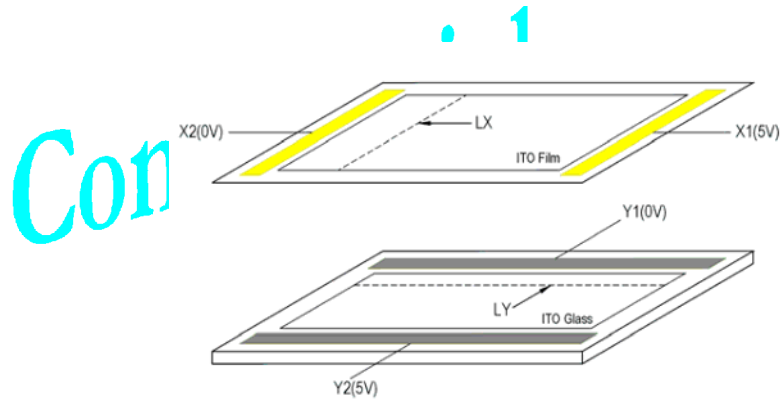

SPK ELECTRONICS CO., LTD.

10. APPEARANCE INSPECTIONS

外觀檢驗說明

(1) The flaws and impurities are allowed outside viewing area except for those affecting electrical functions.

不影響產品電氣功能的情況下可視區之外允許有裂傷和髒污。

(2) The inspection shall be performed by using one 1200±200LUX fluorescent lamp as back or side light. The panel shall be placed at 30cm away from eyes as shown below.

使用1200±200LUX亮度的日光燈和觸控面板放在距眼睛30公分做檢驗。

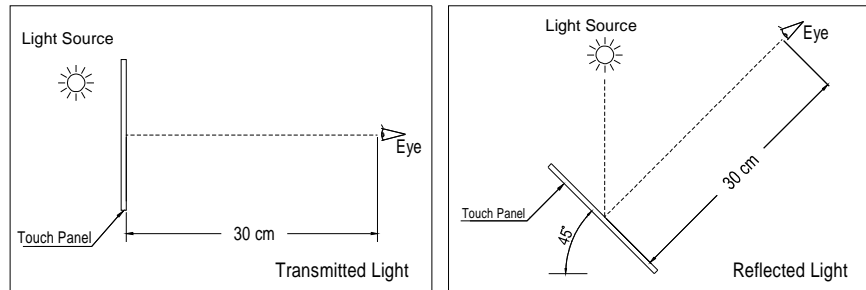

(3) Glass flaw 玻璃裂傷

Confidential

<p>Corner flaw 角裂傷</p>		<p>Please refer to page 12, item 14 參看第 12 頁 第 14 項</p>
<p>Edge flaw 邊緣裂傷</p>		<p>Please refer to page 12, item 14 參看第 12 頁 第 14 項</p>
<p>Progressive flaw 逐漸裂傷</p>		<p>Not allowed 不允許</p>

T=Glass thickness

SPK ELECTRONICS CO., LTD.

T
:

玻璃厚度

SPK ELECTRONICS CO., LTD.

11. INSTALLATION

GUIDE

組裝注意事項

- (1) Front Bezel Opening must be located between View Area and Active Area.
外殼的開口要設計在可視區和動作區之間。
- (2) Elastic materials are recommended as supports to fix the Touch Panel.
建議使用彈性材質來固定觸控面板。
- (3) Support materials must be designed out of the Silver Bar.
將背膠或泡棉材質的設計不可超過銀線的內側。
- (4) Front Bezel Opening must be designed with enough gap to the Touch Panel surface in any conditions.
無論在靜態或外殼有施力的情況下，外殼和觸控面板表面之間要有足夠的空隙。
- (5) **Avoid direct metal contact with edges of the Touch Panel after mounting.**
組裝之後應避免金屬物直接碰觸到面板的外側邊緣。

- * (6) The area between the View Area and Active Area is a none-input area, and the areas along the edges near Active Area are very fragile. It is absolutely forbidden to draw lines along the edge of this area because it will cause damage on the ITO layer and functional failure of the Touch Panel.**

觸控面板的可視區和動作區之間的區域為禁止輸入區，動作區的邊緣為脆弱區。嚴禁在此區內邊緣劃線，如此會造成薄膜的 ITO 層被破壞而觸控面板喪失功能。

- * (7) If the applications of customer need to draw lines along the edges, please contact Liyitec's engineer to discuss the design of the Front Bezel.**

若客戶的使用需要在邊緣畫線，請連絡理義工程師討論外殼的機構設計。

- * (8) This installation guide is only for customer reference.**

此組裝方式僅供客戶參考。

可視區 至少0.5mm

脆弱區

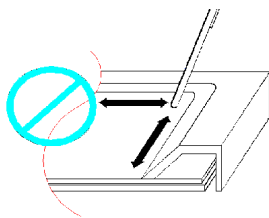

至少0.5mm
外殼開口
Front Bezel Opening(1)
動作區
ITO脆弱點

***注意：請特別注意第 6、7 和 8 項。**

顯示板顯示區
液晶顯示板外殼

***Note: Please take attention seriously on items 6, 7 and 8.**

SPK ELECTRONICS CO., LTD.

背膠或泡棉 外殼
 ITO薄膜 邊緣
 ITO玻璃

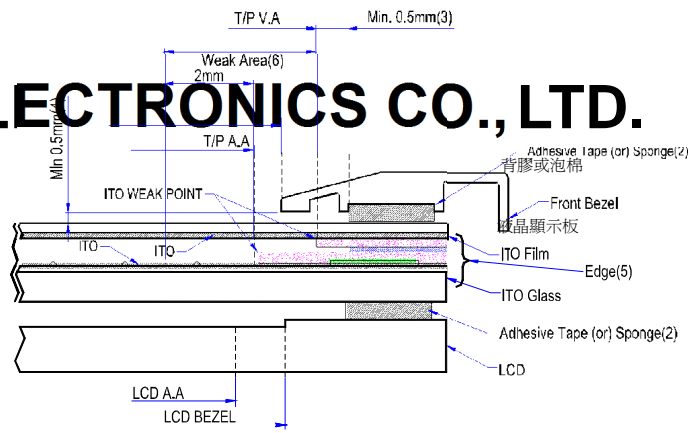

12. WARRANTY

With the exceptions listed below, all SPK's products are guaranteed free of manufacturing defects for a period of up to one year. All defected products will be repaired or exchanged free of charge if determined to be sole responsibility of SPK. SPK reserves the sole discretion in determining the causes and the responsibilities of any defects or damages. For details, please refer to SPK's "Product Warranty Policy".

產品保固

本產品除了以下例外條件之外其保固時間為一年，凡屬本公司責任之出廠不良，會提供免費維修或換新品服務。細節請參看“產品保固條例”。

List of Exceptions:
例外條件:

1. Damages caused by improper handling of clients, including and not limited to, during shipping or manufacturing processes.
客戶操作不當(含製程和運送)造成的損傷。
2. Damages caused by disasters, either by natural causes or human factors, after the delivery of products.
出貨後天災(或)不可抗拒的因素(或)其他人為因素造成的損傷。
3. Any repairs, modifications or disassembling of SPK's products without prior notification to and the consent of SPK.
未經本公司同意，客戶自行拆卸、維修和更改造成的損傷。

Confidential

13. CAUTIONS

注意事項

Storage 儲存	(1) Store packaged products at the temperature and humidity mentioned in the specification with care. Do not expose products to direct sunlight or stress such as that caused by piling. 請將產品儲存在規範溫度和濕度環境，勿將產品直接曝曬在陽光下或堆疊。
Unpacking 拆卸	(1) Check for the correct vertical direction of the package before unpacking. 拆包裝之前先確認包裝的拆封方向。
Handling 拿取	(1) Clean finger sacks or gloves and mask are required during handling to prevent finger-prints or stain on the products and damages to the products caused by sharp edges. 拿取時請將手清洗乾淨、帶手套和口罩，以免手指紋和異物髒污到產品。 (2) Do not handle the viewing area of the panel. 拿取時勿觸可視區。 (3) Do not handle the panel at the tail (connector) to prevent detachment of the tail to the panel. 勿從排線拉起，以免排線受損。
Cleaning 清潔	(1) Clean soft clothes with neutral detergent or ethanol may be used for cleaning. 使用乾淨的軟布沾上酒精或天然清潔劑清潔產品。 (2) Do not use any chemical solvent, acidic or alkali solution. 勿用化學藥劑或酸性或鹼性溶劑。 (3) Any use or soaking of liquid which may result peeling or malfunctioning of the film and glass is prohibited. 任何會對薄膜與玻璃黏合產生不良影響的液體或者浸泡皆一概禁止。
Installation 組裝	(1) Excessive force or strain to the panel or the tail is prohibited. 禁止在面反和排線上施加壓力。 (2) Please take attention seriously on 6, 7 and 8 of items 11, Installation Guide on Page 9. *: 請特別注意第 9 頁,第 11 項的 6、7 和 8。
Operating 操作	(1) Operate with a stylus (tip R0.8 or over), or with a finger without applying excessive load. Sharp edged or hard articles are prohibited. 使用 R0.8 觸控筆或手指操作。避免尖銳物觸碰面板表面。 (2) The gathering of dew in the panel may occur with abrupt temperature or humidity changes. A stable environment condition is recommended. 溫度和濕度突變的情況下，表面會產生霧氣。建議在穩定的環境下使用。
Environment 環境	At SPK, a print-coated metal is used as electrodes. Therefore do not used T/P in an atmosphere which contains erosive gases. 本公司的產品上有金屬印刷線路，故請勿在具有腐蝕性氣體的環境下使用本公司產品。
Others 其他	(1) Keep the surface clean. No adhesives should be applied. 表面不可塗抹粘著劑並保持清潔。 (2) Avoid high voltage and static charge. 避免高壓和靜電。 (3) SPK reserves the right to substitute materials with the same grade and specification. 本公司保有同規格的材料變更權利。 (4) Above specification is for reference only. For details, please contact: spktw@lms34.hinet.net 本規格書儘供參考，如有特殊需求，請洽 spktw@lms34.hinet.net

14. APPEARANCE SPECIFICATIONS

外觀檢驗規範

Defect Name 缺陷	Criteria 規範	Judgment 判定
Particle 異物	$D \leq 0.25$	OK
	$0.25 < D \leq 0.3$	Each Area ⁽³⁾ ≤ 2 , Total ≤ 5 , OK 每區 ⁽³⁾ ≤ 2 , 共 ≤ 5 , OK
	$D > 0.3$	NG
Blur Stain and Interference Pattern 髒污和異紋	$D \leq 0.25$	OK
	$0.25 < D \leq 0.3$	Each Area ⁽³⁾ ≤ 2 , Total ≤ 5 , OK
	$D > 0.3$	NG
Linear Object 外來線狀物	$W \leq 0.05$ and $L \leq 12$	OK
	$0.05 < W \leq 0.1$ and $L \leq 12$	Total ≤ 3 , follow Condition 1, OK
	$W > 0.1$ and $L > 12$	NG
Scratch 刮傷	$W \leq 0.05$ and $L \leq 12$	OK
	$0.05 < W \leq 0.1$ and $L \leq 12$	Total ≤ 5 , follow Condition 1, OK
	$W > 0.1$ and $L > 12$	NG
Damage to Glass 玻璃的裂傷 A: corner flaw 角裂傷 B: Edge flaw 邊緣裂傷	$X \leq 2$, $Y \leq 2$, $Z \leq T$ Please refer to the figures in page 8	Total ≤ 2 , OK Damages with possible worsening are not allowed. 不允許有可能會繼續裂的裂痕。
<p>Condition 1: Distance between defects should not be less than 20mm. 條件(一): 兩個不良處之間的距離要 20mm 以上。</p> <p>Note 1: Particle, Stain or Linear Object that can be clean out easily within 3 times is disregarded. 註(一): 異物、髒污、條狀物正常擦拭3次可去除,即可允收。</p> <p>Note 2: All dimensions are in mm unless otherwise specified. 註(二): 尺寸單位為 mm, 除非另有標示。</p>		

Item	Name of Defect	Definition
1	Dimension 尺寸	D: Average Diameter; W: Width; L: Length; T: Glass Thickness; D: 平均直徑; W: 寬度; L: 長度; T: 玻璃厚度
2	Inspection Area 檢驗區	According to engineering drawing, Viewable Area is the Inspection Area. Any defect outside of the Viewable Area may be disregarded. 依工程圖的可視區為檢驗區域。可視區以外的不良可忽略。
3	Each Area 每區	One of the areas of T/P Viewable Area divided into 9 (3 by 3) equal areas. 將觸控螢幕平均分割為3x3的9個區域, 每區為其中一個區域。
4	Stain 髒污	No clear outline, not easy to identify with eyes, but able to clean out by wiping. 輪廓不清晰,以肉眼辨識不易的沾污或與觸控面板表面有明顯色差,存在於觸控面板表面,可擦拭乾淨。
5	Interference Pattern 異紋	No clear outline, not easy to identify with eyes and unable to clean out by wiping. 輪廓不清晰,以肉眼辨識不易的沾污或與觸控面板表面有明顯色差,存在於薄膜與玻璃內部,無法擦拭乾淨。

15. Durability Testing Method

耐久測試方式

1. Finger Touch: 打點測試方式:

- ④ Test Position: Center of Active Area (Fig. 1)
測試位置: 動作區的中心。(圖. 1)
- ④ Test Pen R8.0 Silicon Rubber Hs50~60°. (Fig. 2)
測試筆: R8 橡膠頭 Hs50~60°(圖.2)
- ④ Test method: Knock at the single point
測試方式: 打在同一個點。

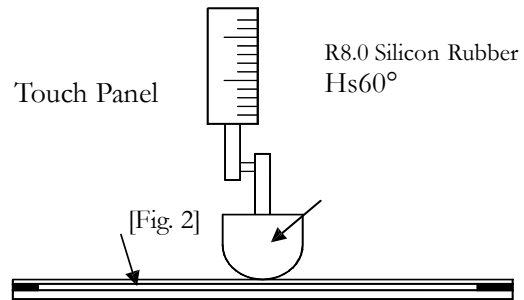
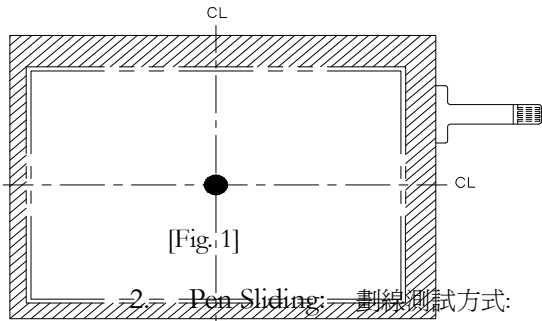

- ④ Test Position: Center of Active Area, 40mm×40mm. (Fig 3)
測試位置: 動作區的中心, 40mm×40mm.(圖.3)
- ④ Test Pen R0.8 polyacetal Stylus. (Fig. 4)
測試筆: R0.8 塑膠筆。(圖.4)
- ④ Test Method: Write in active area.
測試方式: 寫在動作區。

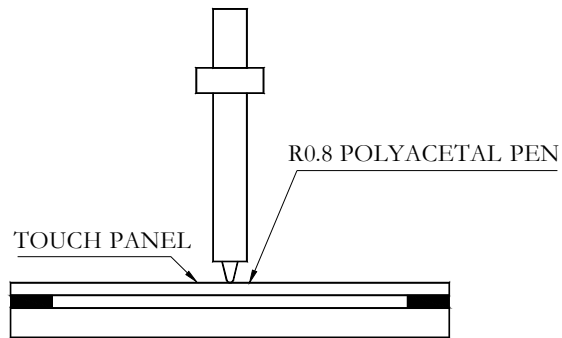
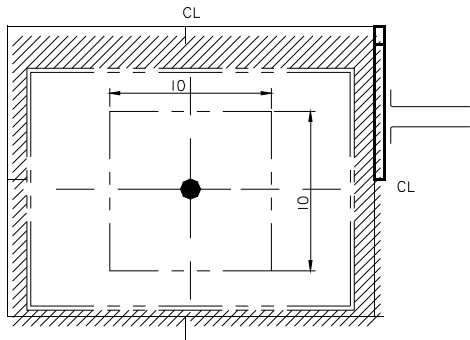

16. Cautions for Product Handling

Note: To prevent malfunction as a result of improper handling

of touch panel product, please make sure that the following instructions are followed:

- 1、Wear gloves at all time upon handling touch panel, and hold touch panel only at the edge of the panel.
- 2、Use only the standard polyacetal rod pen (with a radius of 0.8 at the end of the rod) for product testing.
(Fig: 1,2,3)

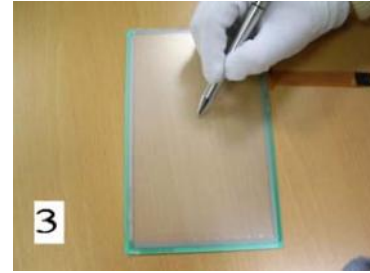
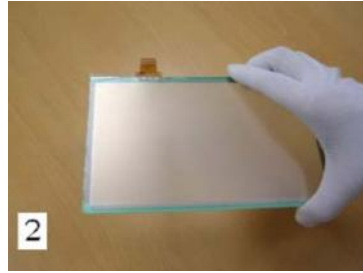
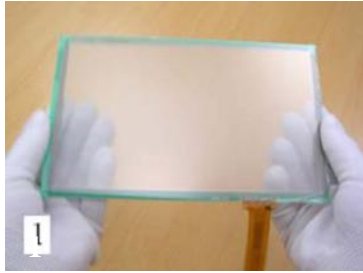

- 3、Do not lift touch panel via the connector (Tail). [Excess force applied on the Tail may cause displacement of the connector or cracks at the base of the panel.] (Fig: 4,5,6)
- 4、Do not handle the touch panel via the surface of the panel. [Excess force applied on the touch panel may crack the glass layer of the touch panel.] (Fig: 7,8)
- 5、Do not pile up touch panels together or place heavy substance on the touch panel. [Excess stress on the touch panel may scratch the surface of the touch panel, or crack the touch panel.] (Fig:9,10)
- 6、Do not touch the surface of the touch panel via sharp objects. [Sharp objects may cause scratch on the surface of the touch panel.] (Fig: 11)
- 7、Do not place the face of the film on the table or any other surface. [Various objects on the table may scratch the surface of the touch panel.] (Fig: 12)

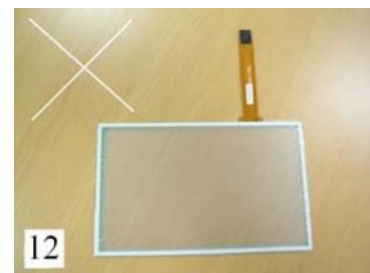
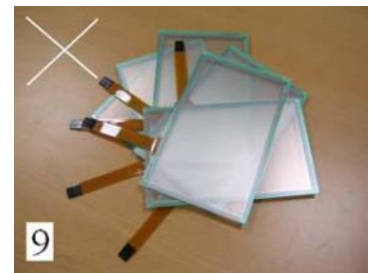
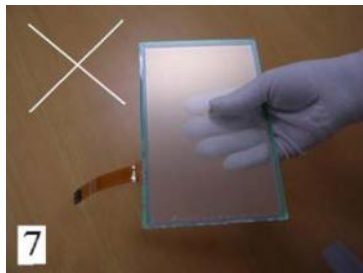
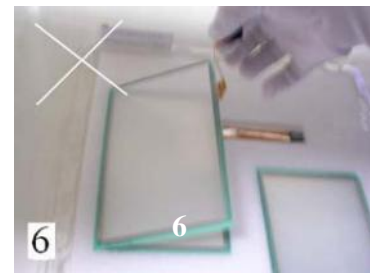
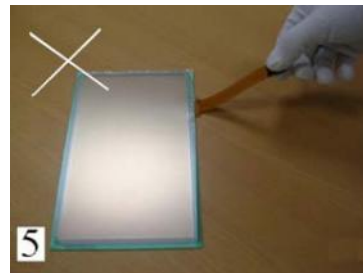
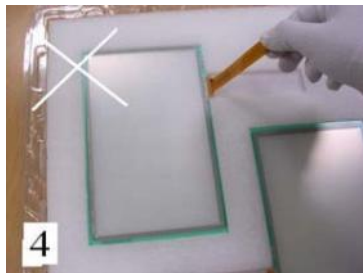

17. Packing Method 包裝方式

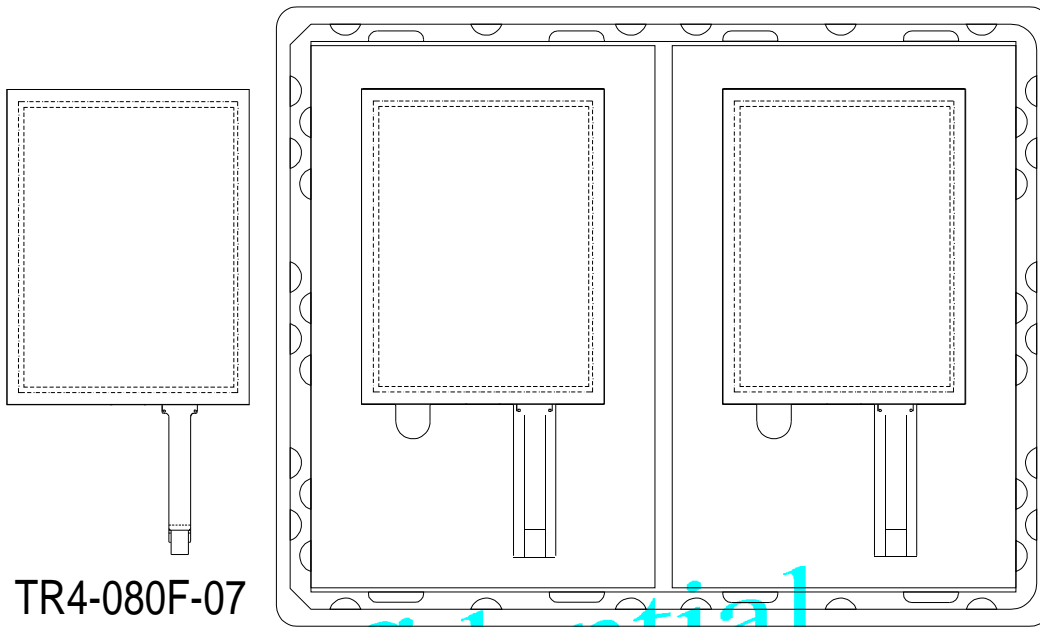

2 PCS of T/P per Tray

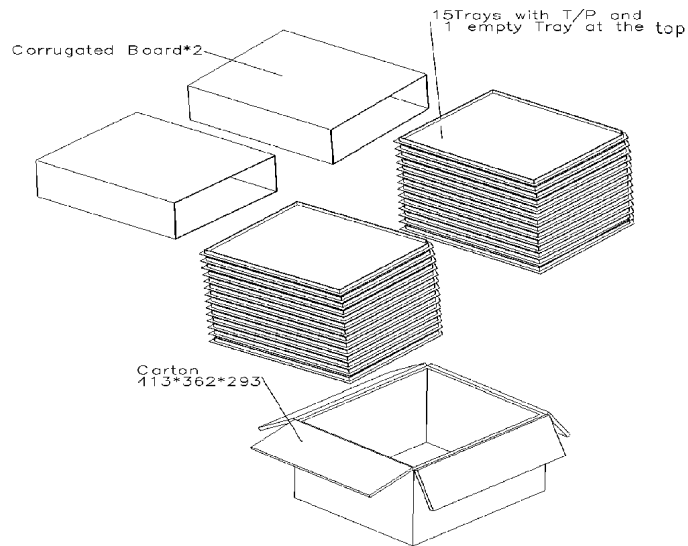

Packing Qty: 30 pcs per carton.